



V-Series
Oil-less Rotary Vane





Oil-less rotary vane vacuum pumps, compressors and pressure-vacuum pumps

The compact V-VTE vacuum pumps and V-DTE compressors are each available in four sizes. Low noise and reliability make this series an ideal choice for many OEM applications.

Our medium size oil-less pumps are available in vacuum (V-VLT), pressure (V-DLT) and combination models (V-KLT). Design features of these include maximized cooling air pathways, heat resistant materials, sound reduction covers and relief valves.

Our largest group of oil-less rotary vane pumps also offers all operation types – vacuum (V-VTR), pressure (V-DTR) and combination models (V-KTR). Developed as continuous duty pumps for printing and paper handling machines, this new series is now used widely in many industrial applications.

Advantages at a glance

- Low noise level
- Easy to operate
- Dry running, environmentally friendly
- Process safe and reliable
- Robust and economical
- Many accessories
- Worldwide service
- Maintenance friendly

Oil-less rotary vane vacuum pumps

V-VTE

Capacities ranging from 2 to 7 cfm, ultimate vacuum 25.5 in. HgV. Compact, easy to install. Very low noise level. Corrosion resistant rotors. Hose connection and exhaust silencer as standard.

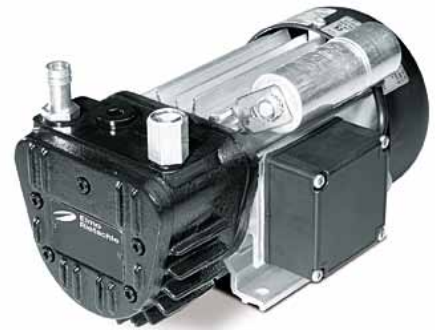

V-VTE

V-VLT

Capacities from 8 to 30 cfm, ultimate vacuum of 25.5 in. HgV. Sound cover reduces noise level, enhances cooling and protects operator from touching hot surfaces. Comes with built-in suction filter and vacuum valves. Low vibration, easy to operate, install and service.



V-VLT

V-VTR

Capacities from 39 to 91 cfm, ultimate vacuum of 25.5 in. HgV. Bearings on both sides of the rotor. Flange mounted motor with bolt coupling. High efficiency and low noise operation. Sound cover allows a ducted cooling air outlet either from one side only or from both front and back. (60-80 size) Easy to operate and service.



V-VTR

Oil-less rotary vane compressors



V-DTE



V-DLT



V-DTR

V-DTE

Capacities from 2 to 7 cfm, pressure up to 14.5 psig. Compact design, easy to build into machines, very low noise level. Hose connector, inlet silencer and pressure relief valve fitted as standard.

V-DLT

Capacities from 8 to 31 cfm, pressure up to 14.5 psig. Fitted with integral suction air filter. Sound cover provides low noise level and intensive cooling and protects from touching hot surfaces. Flexible connections supplied, vibration free, easy to install, operate and maintain. Can be fitted with an internal compressed air after-cooler if required.

V-DTR

Capacities from 36 to 91 cfm, pressure up to 22 psig for continuous operation and up to 32 psig for intermittent operation. Bearings on both sides of the rotor. Flange mounted motor with bolt coupling. High efficiency and low noise operation. Sound cover allows a ducted cooling air outlet, from one side. Easy to operate and service.

Oil-less rotary vane pressure-vacuum pumps

V-KLT

Capacities from 11 to 30 cfm, vacuum up to 18 in. HgV, pressure up to 9 psig. Integral suction and compressed air filters. Sound cover provides a low noise level, optimal cooling and protects from touching hot surfaces. Low vibration, easy to install, operate and service. Complete with compressed air after-cooler.



V-KLT

V-KTR

Capacities from 28 to 95 cfm, vacuum up to 18 in. HgV, pressure up to 10 psig. High efficiency and low noise level. Sound cover allows a ducted cooling air outlet. Easy to operate and service.



V-KTR

Operating principle

Pressure increase by volume reduction is the principle behind rotary vane operation. This design offers excellent service in pressure, vacuum or a combination of both.

In a cylindrical housing (1) a rotor (2) is positioned eccentrically so that it is on the top almost touching the cylinder. Rotor blades or vanes (4) as they are called, are positioned inside rotor slots (3). When the rotor starts turning, due to centrifugal force the blades are thrown out and slide against the internal surface of the cylinder. In this way a cell (5) is formed between two blades with a volume that changes constantly during rotation. Air enters from the inlet port (6) into a cell until the rear blade reaches the far end of the inlet port (7). At this point the cell (5) has achieved its maximum air volume. As the cell then moves away from the port its volume becomes smaller and smaller, the air is thus compressed and the pressure rises.

This continues until the pressure in the cell (8) exceeds that in the pressure chamber (9) and the compressed air then exits through the outlet port (10).

Some models are fitted with exhaust valves which stop the backflow of this discharged air if the maximum pressure has been reached. In a vacuum pump the process is similar, but the cell (8) gives decreasing pressure, and the chamber (9) is at atmospheric pressure.

With pressure-vacuum pumps the lower end of the inlet port(s) (6) for the vacuum is moved forward. The cell can now be filled through second inlet (11). To avoid impairing the vacuum, this second inlet port is located about one cell segment away from the main suction port. The ratio between vacuum and pressure capacities can be influenced by the choice of inlet port (6 and/or 11).

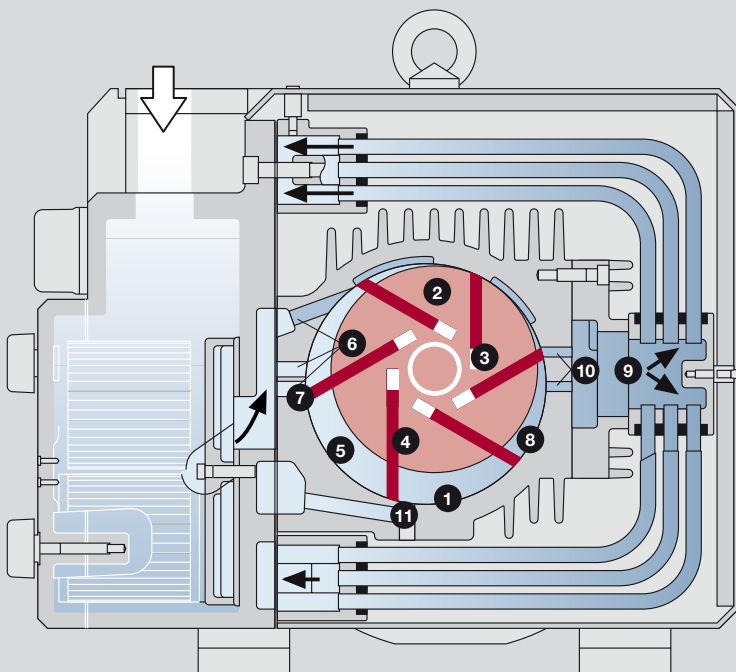

Technical specifications

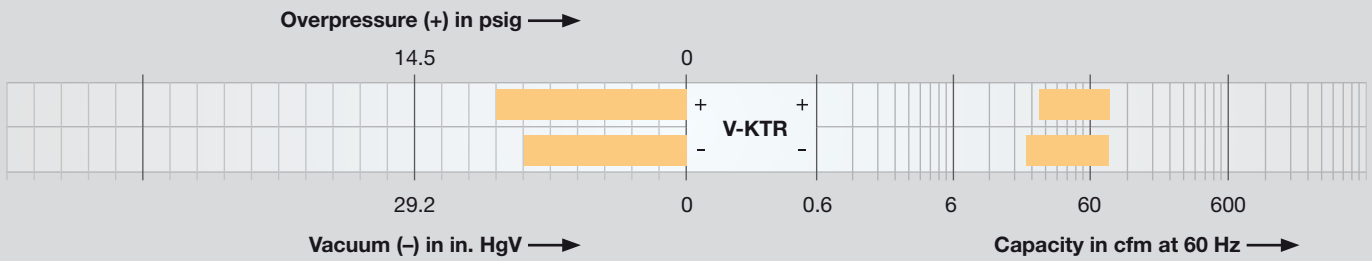
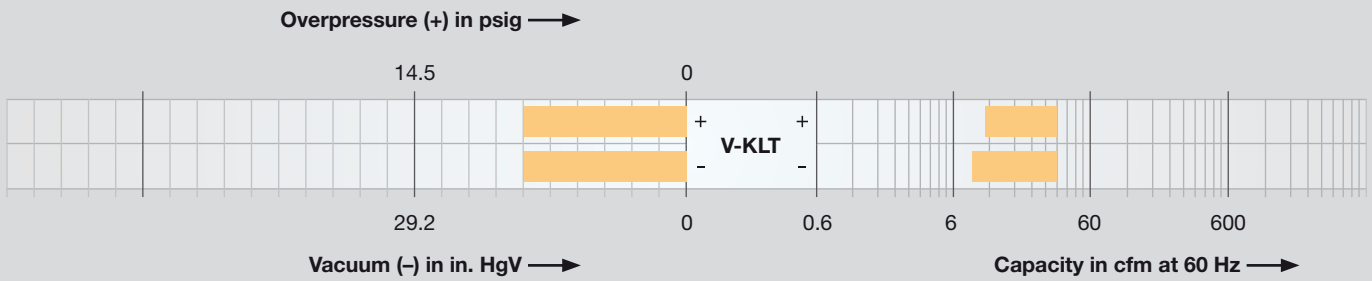
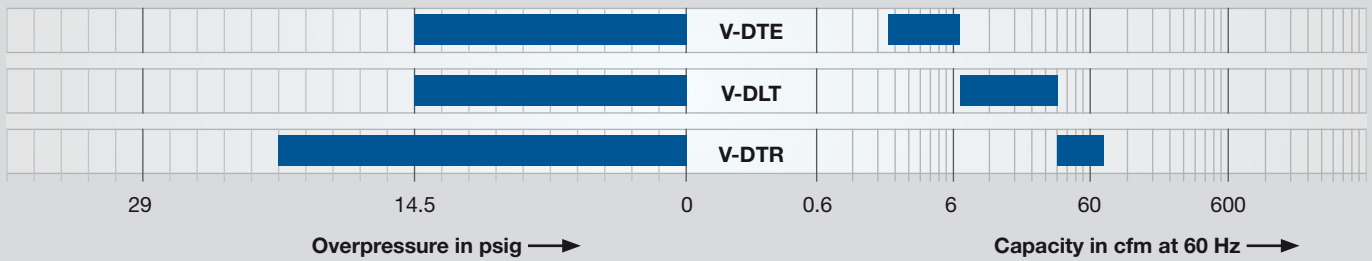
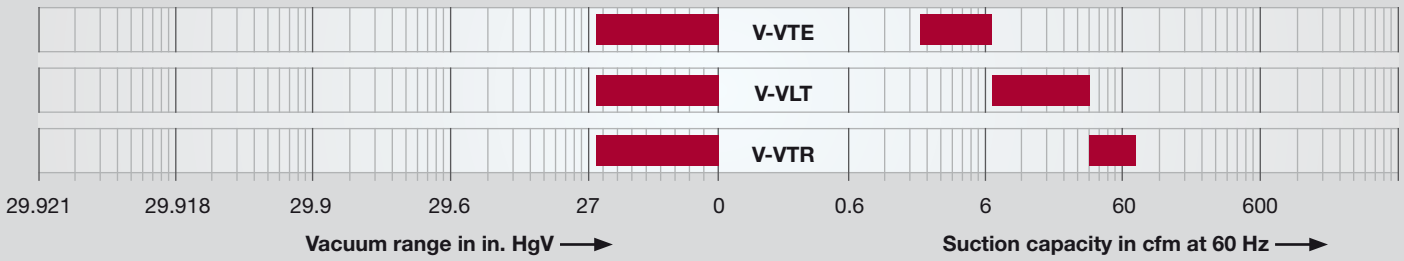



Applications



Environmental engineering

- Aeration

Industrial applications

- Lifting and holding
- Pick and Place

Packaging industry

- Packaging machines

Printing industry

- Post-press applications
- Printing presses

Woodworking industry

- Vacuum hold down

Gardner
Denver[®]



Member



www.gd-elmoietschle.com ElmoRietschle@gardnerdenver.com

Gardner Denver, Inc. 1800 Gardner Expressway, Quincy, IL 62305
Telephone: (800) 682-9868 FAX: (217) 221-8780